

**ACE**



# CONTENTS

<b>Conventions</b> .....	2
<b>Overview</b> .....	3
1 Kit Contents .....	3
2 Quadcopter Introduction .....	5
<b>Preparations before flight</b> .....	5
<b>1 Preparing Batteries</b> .....	5
1.1 Quadcopter Battery Introduction .....	6
1.2 Charging the Quadcopter battery .....	6
1.3 Quadcopter Battery Installation .....	7
1.4 Quadcopter Propeller Guard Attachment Instructions .....	7
1.5 Caution .....	7
<b>2 Preparing the Quadcopter</b> .....	8
2.1 Introduction .....	8
2.2 Flight Control System .....	8
2.3 Flight Indicator .....	8
2.4 Remove the Buckle and Install the Camera .....	9
2.4.1 Remove the Buckle: .....	9
2.4.2 Install the Camera: .....	10
2.5 Airborne Camera .....	10
<b>3 Preparing Propellers</b> .....	10
3.1 Introduction .....	10
3.2 Assembling Propellers .....	10
3.3 Disassembling Propellers .....	11
3.4 Precautions .....	11
<b>4 Preparing the Remote control</b> .....	11
4.1 Introduction .....	11
4.2 Indicator on the Remote control .....	13
4.3 Powering on the Remote control .....	13
4.4 Antenna Orientation .....	14
4.5 Operating the Remote control .....	14
4.6 Frequency Pairing between Remote control and Receiver .....	15
<b>5 Preparing the Repeater</b> .....	16
<b>5.1 Introduction</b> .....	16
5.1.1 Wi-Fi Indicator .....	16
5.1.2 Power Indicator .....	16
5.1.3 Pairing Button .....	16
5.1.4 Code Pairing .....	16
<b>5.2 How to use</b> .....	16
Charging the Repeater .....	16
Switching on the Repeater .....	16
<b>6 Downloading and Installing AEE ZONE App</b> .....	17
<b>7 Connecting the Camera</b> .....	17
<b>Flight</b> .....	18
Flight Environment Requirements .....	18
Pre-flight Check: .....	18
<b>1 Compass Calibration</b> .....	18
1.1 Calibration Procedures .....	18
1.2 When to Recalibrate .....	18
<b>2 Starting / Stopping the Motor</b> .....	19
2.1 Starting the motor .....	19
2.2 Stopping the Motors .....	19
<b>3 Basic Flight</b> .....	19
3.1 Basic Flight Procedures .....	19
3.2 Aerial Photography Tips and Tricks .....	20
<b>4 Failsafe Protections</b> .....	20
4.1 Scenarios when Quadcopter enters Failsafe mode .....	20
4.2 Failsafe Procedure .....	20
4.3 How to regain control during Failsafe Procedures .....	20
<b>5 Low Battery Level Alarm Function</b> .....	20
<b>Software Upgrade Interfaces on PC</b> .....	21
1. Software Installation .....	21
2. Driver Installation .....	21
3. Interface Explanation .....	21
4. Upgrade Steps .....	22
<b>Appendix</b> .....	23
1 Description of Common Indicators .....	23
2 Specifications .....	23
3 Common Troubleshooting .....	23
<b>Limited Warranty</b> .....	25

# Quadcopter User Manual

V1.0 2017.7

Please read this "User Manual "carefully before using Quadcopter.

## Conventions

Except when specifically stated, all quadcopter features described in this manual are for Quadcopter Operating Modes.





### **Warning :**





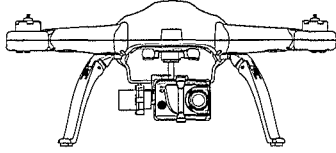

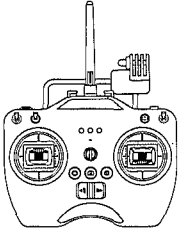
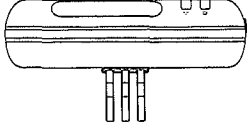

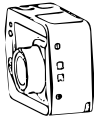
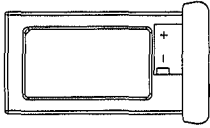
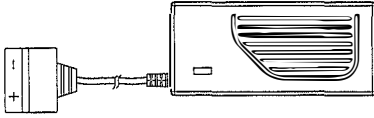
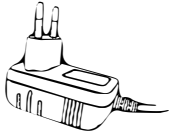
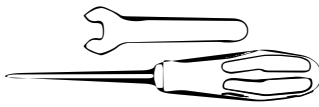
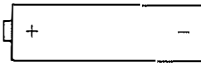
- (1) When installing the propellers, rotate the propellers strictly in the lock direction specified by the mark, and DO NOT apply too much force in order to avoid possible damage.
- (2) When removing the propellers, rotate the propellers strictly in the unlock direction specified by the mark, in order to avoid possible damage.

The quadcopter is a high-tech electronic with integrated flight and camera control. When install camera, you can use mobile devices to control the camera through the App and achieve real-time video images. The quadcopter will help you capture clear and stable aerial videos and photos.  
 Note:The camera operation as mentioned below, is only applied for the operation of the AEE S60 Plus.

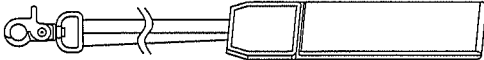
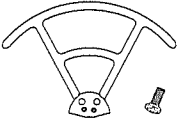
## 1 Kit Contents

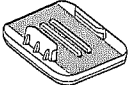
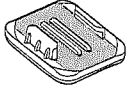
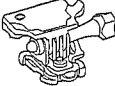
Before using, please check all items inside the kit box.

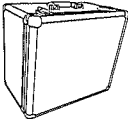
No.	Name	Diagram	Quantity	Description
1	Quadcopter		1 pcs	Camera is optional
2	Propellers		4 pairs	4 pcs with black nuts; 4 pcs with gray nuts
3	Remote control		1 pcs	With Wi-Fi Repeater Base
4	Wi-Fi Repeater		1 pcs	For connecting mobile devices through Wi-Fi
5	Smartphone Holder		1 pcs	For attaching mobile devices
6	Camera		1 pcs	S-series camera
7	Quadcopter Battery		1 pcs	Quadcopter power supply
8	Quadcopter Battery Charger		1 pcs	100-240V 50/60Hz
9	Wi-Fi Repeater Adapter		1 pcs	100-240V 50/60Hz (optional)
10	Tools		1 set	1pcs wrench - (for disassembling propeller ) and 1pcs screwdriver (for assembling propeller guard)
11	AA batteries		4 pcs	For Remote control power supply

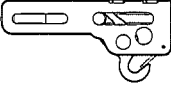
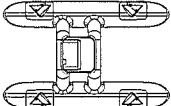
12	Manuals		1 pcs	Including: Quadcopter User Manual , Quadcopter Quick Start Guide,Disclaimer
13	Screws		1 pcs	For Wi-Fi Repeater (optional)
14	Lanyard		1 pcs	Remote control Lanyard
15	Propeller Guards		1 set	Including 4 Propellers Guards and 8 screws.
16	CD		1 pcs	Containing User Manual, etc.. (optional)
17	Micro SD card		1 pcs (16GB/32GB /64GB)	Inserted in Quadcopter Micro SD card port (optional)
18	Flat sticker		1 pcs	Flat accessory (optional)
19	Arc sticker		1 pcs	Arc accessory (optional)
20	Support assembly		1 set	Support assembly (optional)
21	USB cable		1 pcs	S-series USB cable (optional)
22	Aluminum case		1 pcs	(Optional)
23	Bag		1 pcs	(Optional)
24	Hook		1 pcs	It can be used to hang / airdrop lightweight objects (optional)
25	Float		1 pcs	Accessory for overwater take-off / landing (optional)

• Accessories you have received may vary due to different product customizations. Package contents are subject to change without further notice.

Adopting high-standard integrated design . If it is equipped with professional airbr photography equipment and a Wi-Fi Repeater, quadcopter provides excellent flight and aerial photography for outdoor or large indoor spaces. You only need to follow some simple installation steps before flight and taking aerial pictures. You can control the quadcopter through the remote control, and can view flight video through mobile devices. Featuring simple and flexible operating procedures, quadcopter has stable and reliable performance, and can be used for amateur or commercial photography.

Remote control Device	Quadcopter External Components	Operating Modes	Quadcopter Internal Components
Remote control with 2 joysticks, multi-channel	Gimbal Power units (motor and blades) Camera (optional)	GPS mode Normal mode	Flight Control System Wi-Fi module Receiver ESC (Electronic Speed Control)

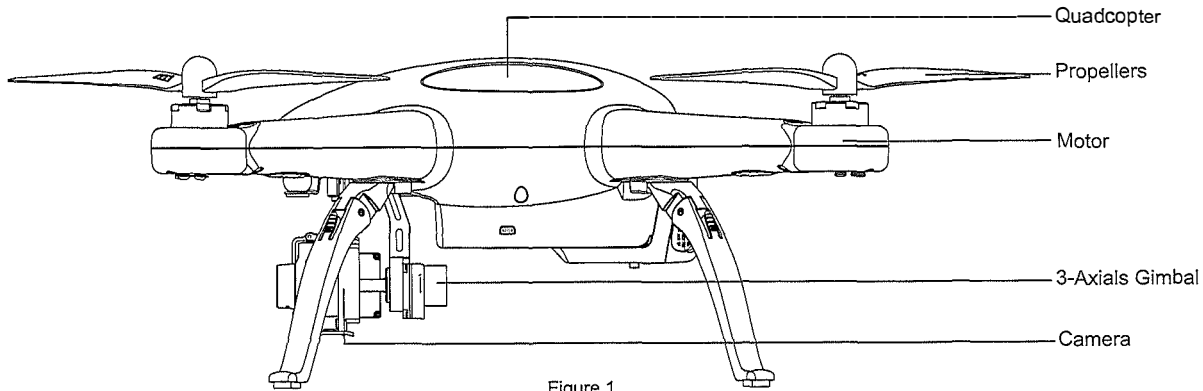

Figure 1

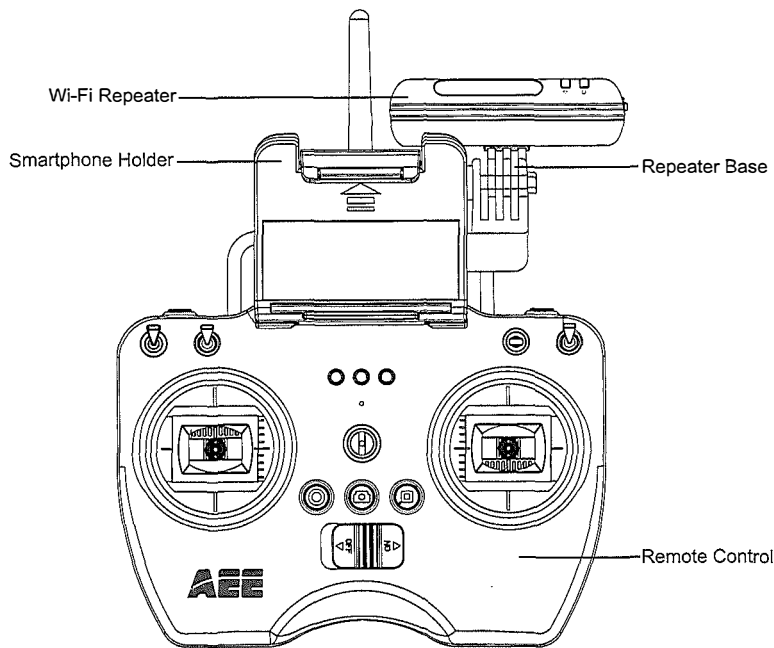

Figure 2

## Preparations before flight

Refer to the following for installing components and pre-flight quadcopter check.

### 1 Preparing Batteries

Ensure all device batteries are fully charged before operating quadcopter.

Device	Power Supply
Quadcopter	Charge quadcopter batteries for power supply
Remote control	Load 4 AA batteries for power supply
Wi-Fi Repeater	Wi-Fi Repeater should be charged through the inbuilt charging port (Mini USB port)
Mobile devices	Please ensure that your mobile device is fully charged before using App

The following instructions are for the quadcopter battery.

### 1.1 Quadcopter Battery Introduction

The quadcopter battery (Figure 3) is a specifically designed battery for quadcopter with charge and discharge management functions, with voltage of 11.1V. Only use the dedicated quadcopter battery charger (Figure 4) provided by AEE, for charging.

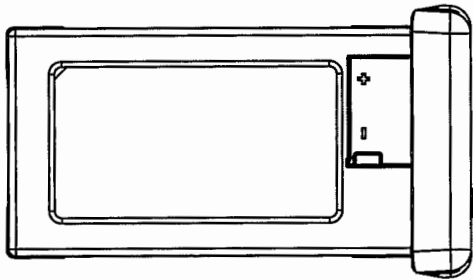

Figure 3

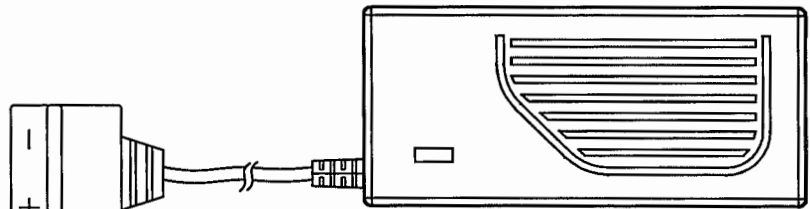

Figure 4

Short press the Battery Level Check button (Figure 5). Battery Level LCD Segment Display displays appropriate battery level. Please fully charge the battery if it is less than two bars.

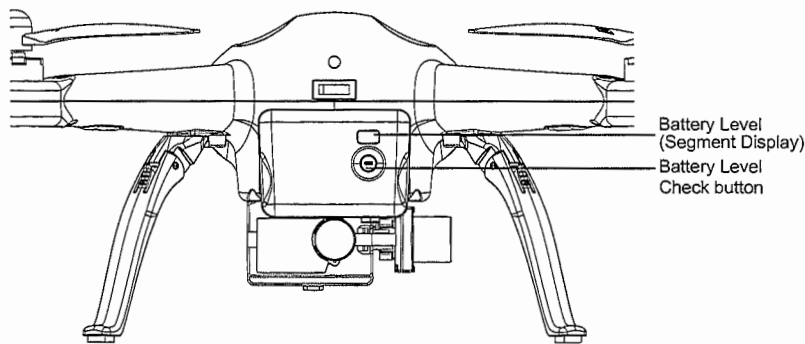

Figure 5

### Battery Specifications

Type	Li-Po Battery
Charging ambient temperature	0°C-50°C / 32~122°F
Discharging ambient temperature	-20°C-50°C / -4~122°F
Charge / discharge ambient relative humidity	< 80%

Please carefully read and strictly comply with this manual before use. Users take full responsibility for any problems caused due to failure to follow instructions.

### 1.2 Charging the Quadcopter battery

- (1) Connect the charger to an AC power source (100-240V, 50 / 60Hz). Please use a power adapter, if necessary.
- (2) While charging, the battery charger indicator turns red.
- (3) When the battery charger indicator turns green, the battery is fully charged. Disconnect the charger and battery when charging is complete.

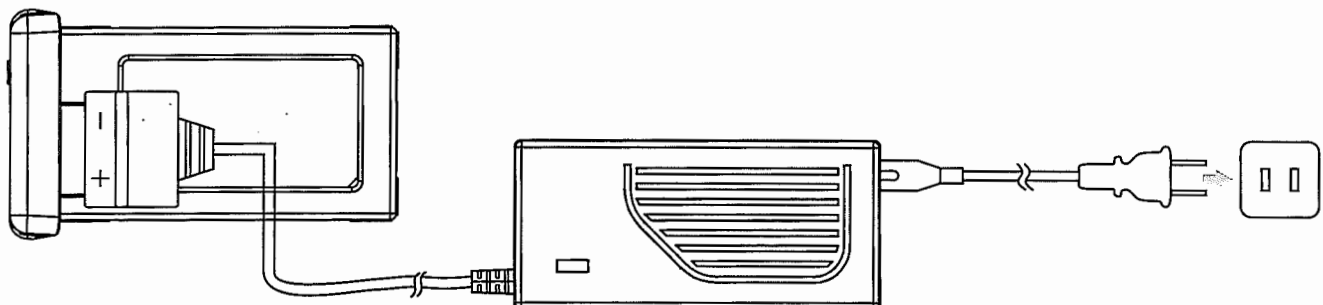

Figure 6

Push the battery into the battery compartment in the correct direction (Figure 7). After the battery is properly installed, a "click" sound will be heard, indicating that the battery has been fastened.

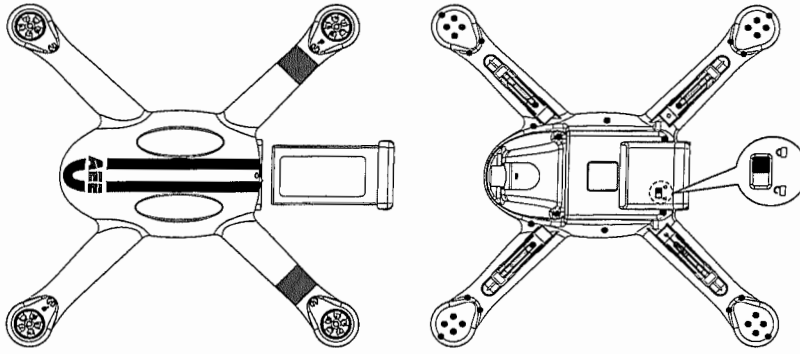

Figure 7

An incorrectly installed battery may cause

- Bad contact
- Affect flight safety
- Inability to take off.

## 1.4 Quadcopter Propeller Guard Attachment Instructions

Please follow the below instructions to attach your Quadcopter Propeller Guards.

- (1) Gather together the Quadcopter Propeller Guards (4) PM3x10 Screws (8), Screwdriver.
- (2) Remove the PM3x6 Screws under each of the four motors (Figure.a).
- (3) Place the Propeller Guards and attach them with the PM3x10 screws (Figure.b). Tighten as required . Do this for all four Propeller Guards. Do not use thread lock.
- (4) Assembly complete(Figure.c)
- (5) Replace back PM3x6 (8) screws on the four motors after remove the Propeller Guards.

**IMPORTANT:** PM3x10 screw is only for Propeller Guards assembly. Without a Propeller Guards, use PM3x6 screw to avoid damaging the motor.

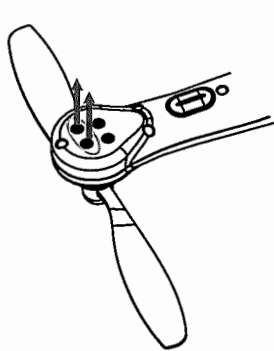

Figure.a Removing Screws

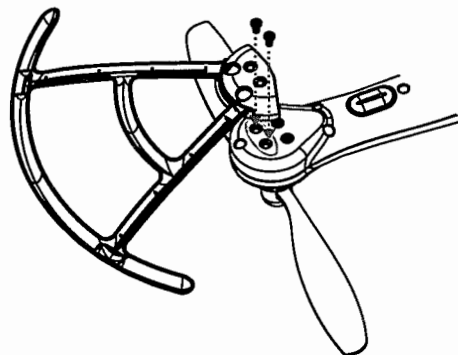

Figure.b Prop Guard Attachment

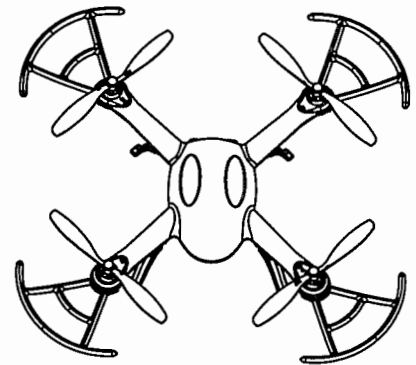

Figure.c Complete

## 1.5 Caution

- (1) Do not directly pull out the battery when the quadcopter is switched on as it may damage the power supply connector.
- (2) If the battery is to be left unused for a long time, it should be discharged to a level of 40-50% (single cell 3.7V-3.9V) and stored in a special battery box. Besides, the battery should be recharged and discharged at an interval of about three months to maintain the battery performance.
- (3) When the battery is charged more than 300 times, replacement of the battery is suggested; please contact a local waste battery recycling organization for disposal.
- (4) Replace the battery if your current battery swells up or is damaged in any way, to avoid fire and explosion.
- (5) Do not charge expanded or damaged batteries.
- (6) Please pay attention to the battery charging process in order to avoid accidents, and make sure there are no flammable or combustible materials around the battery and the charger.
- (7) Battery safety is extremely important. Please refer to Disclaimer for more precautions.



## 2 Preparing the Quadcopter

The Quadcopter consists mainly of the flight control system, gimbal, camera (optional) and power unit.

### 2.1 Introduction

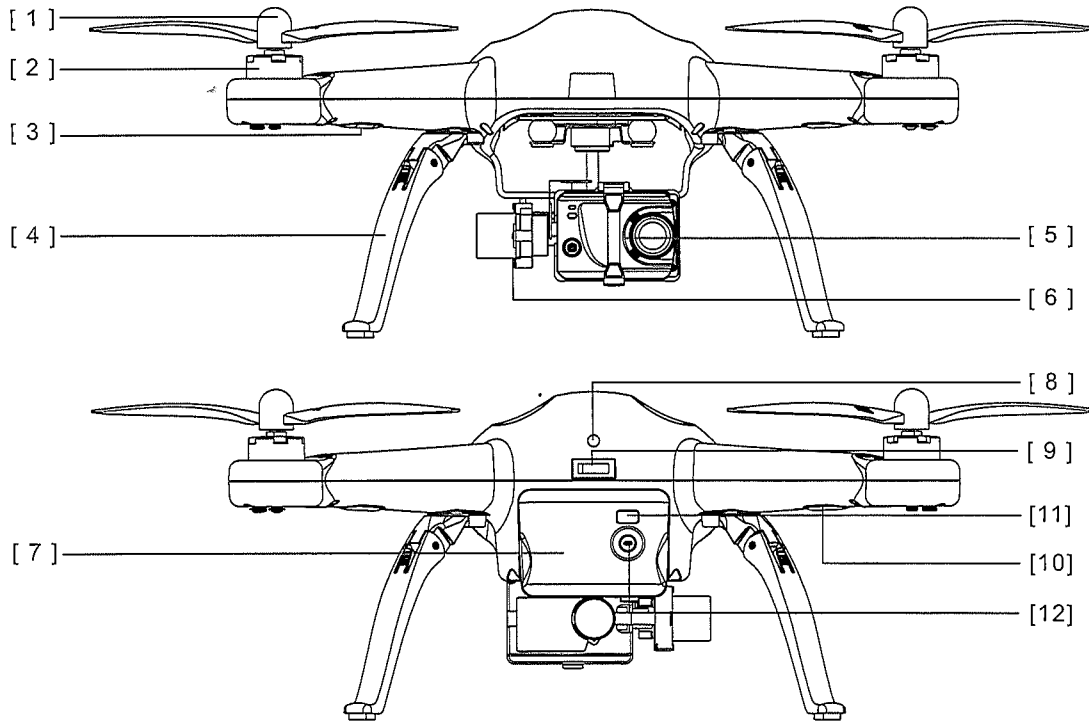

Figure 8

- |                    |                       |  |                                   |
|--------------------|-----------------------|--|-----------------------------------|
| [ 1 ] Propeller    | [ 2 ] Motor           | [ 3 ] Front Indicator                    | [ 4 ] Landing Gear                |
| [ 5 ] Camera       | [ 6 ] 3-Axials Gimbal | [ 7 ] Quadcopter Battery                 | [ 8 ] Tail Indicator              |
| [ 9 ] Power Switch | [ 10 ] Rear Indicator | [ 11 ] Battery Level LCD Segment Display | [ 12 ] Battery Level Check Button |

### 2.2 Flight Control System

Quadcopter is equipped with AEE flight control system to provide incredible ease of use and stability. In addition to supporting basic flight maneuvers such as climb, descend, roll and pitch, it also supports failsafe protection, battery level alarms and other functions.

System Component Modules	Function
Master Controller	The core part of the flight control system controls all modules in a centralized way
GPS & Compass	Used for positioning and navigation
Indicator	Indicates current flight control system status. use to navigate during night flight

### 2.3 Flight Indicator

Flight indicators include the forearm indicator, rear arm indicator and tail indicator. When the quadcopter is powered on, the flight indicators will be turned on – forearm indicator in green (“green indicator”) and rear arm indicator in red (“red indicator”).

**⚠ WARNING:** Do not power on the quadcopter before assembly camera and remove the gimbal buckle, in order to avoid possible damage.

MODE		Tail Indicator (green)					
MODE	GPS normal	Remains ON					
	Searching GPS signal	Blinking slowly (blinking once within 2s)					
WARNING & ERROR		Front Indicator (green)			Rear Indicator (red)		
1 <sup>st</sup> Level low battery alarm		Slow Blink(1s ON,1s OFF)			Slow Blink (1s ON,1s OFF)		
2 <sup>nd</sup> level low battery alarm		Blinking fast (blinking twice fast within 1s)			Blinking fast (blinking twice fast within 1s)		
Compass abnormal		Blinking fast (blinking 3 times within 1s)			Remains ON		
Accelerometer abnormal		Blinking fast (blinking 3 times within 1s)			Blinking fast (blinking 3 times within 1s)		
Gyro abnormal		Remains ON			Blinking fast (blinking 3 times within 1s)		
GPS Module abnormal		Remains ON			Blinking fast (blinking twice within 3s)		
Barometer abnormal		Remains ON			Blinking slowly (blinking once within 2s)		
COMPASS CALIBRATION INDICATOR		Front Indicator (green)			Rear Indicator (red)		
Compass calibration entered		Blinking fast (blinking twice within 1s)			Remains ON		
Compass calibration started		OFF			Remains ON		
Compass calibration Successful		Remains ON			Remains ON		
Compass calibration Failed		Blinking fast (blinking 3 times within 1s)			Remains ON		
		1second	1second	1second	1second	1second	1second

• When abnormal status occurs, please refer to the solutions of Common Troubleshooting.

## 2.4 Remove the Buckle and Install the Camera

Two types of cameras can be installed onto the quadcopter:

1. AEE S50/S51/S60/S61/S71/S70/OM51S/OM60S/OR60S/OR71S/S40;
2. Gopro G3/G4 camera.

### 2.4.1 Remove the Buckle:

Pull out the buckle of the gimbal in the direction shown in Fig. 9a:

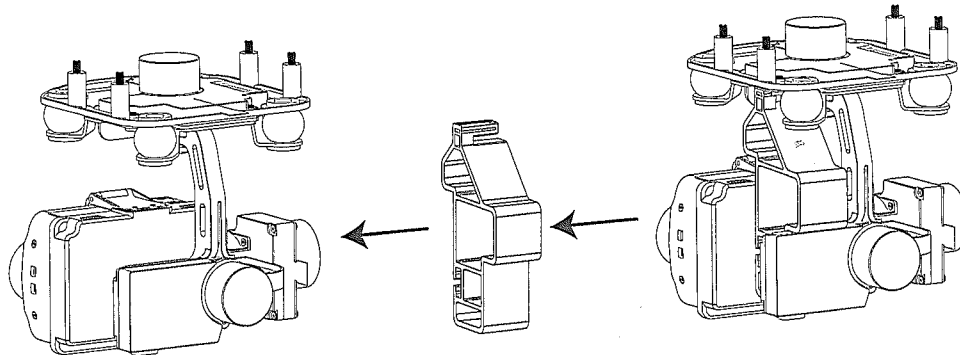

Figure 9a

### 2.4.2 Install the Camera:

Install the camera onto the quadcopter and fix the clip to the camera reliably as shown in Fig. 9b to prevent the camera coming off.

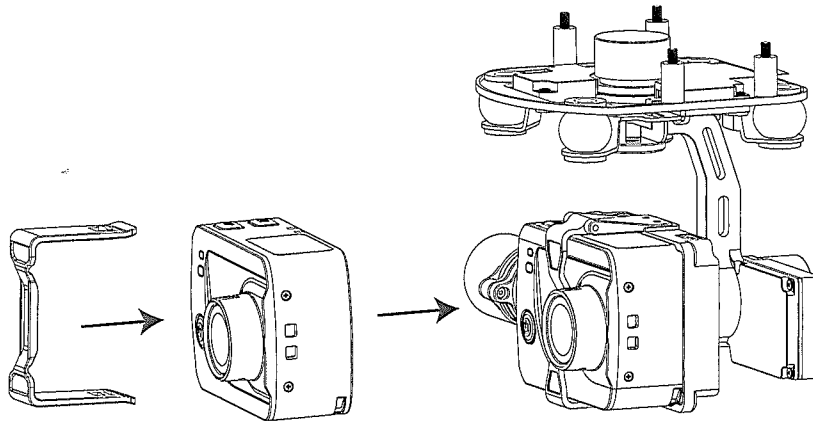

Figure 9b

## 2.5 Airborne Camera

With S60 Plus camera installed on the quadcopter, you can take photos and record videos by App. The camera supports Single Shot and Fast Shot, with video capture resolution up to 1080P / 60fps (N system) 1080P / 50fps (P system) Full HD video.

Camera Specifications	
Resolution	Maximum 1080P / 60fps (N system) ,1080P / 50fps (P system), 720P/120fps
Image Resolution	4608x3456
Video Formats	MP4 (H.264)
Storage	External Micro SD card, up to 64GB
TV system	P / N system optional

Do not handle the camera manually at any time (only use the remote control to control it.), or the camera could be damaged.

### 2.5.1 Camera Function Buttons

Photo shooting: Use the APP to control the airborne camera to take photos.

Video-recording: Use the APP to control the airborne camera to start and stop video recording.

### 2.5.2 Copying Camera Data

Power off quadcopter before removing the Micro SD card from the card port, and connect it to a computer with a card reader to easily copy camera files. (Quadcopter and Camera power must be OFF while removing the Micro SD card).

## 3 Preparing Propellers

Quadcopter adopts 10-inch propellers, with black and gray color propeller nuts. Propellers are consumable items. Please purchase these accessories separately, if necessary.

### 3.1 Introduction

Propellers	Gray (1045)	Black (1045 P)
Diagram		
Assembly Location	Attach to the motor shaft without "P" mark	Attach to the motor shaft with "P" mark
Installation Location	Lockup: Tighten propeller in this direction	
Symbol Description	Unlock: Loosen propeller in this direction	

### 3.2 Assembling Propellers

(As shown below) Prepare two propellers with gray nuts and two with black nuts. Attach propellers with gray nuts to motor shafts without "P" marks, and attach propellers with black nuts to motor shafts with "P" marks. Tighten propellers as per the appropriate locking direction.

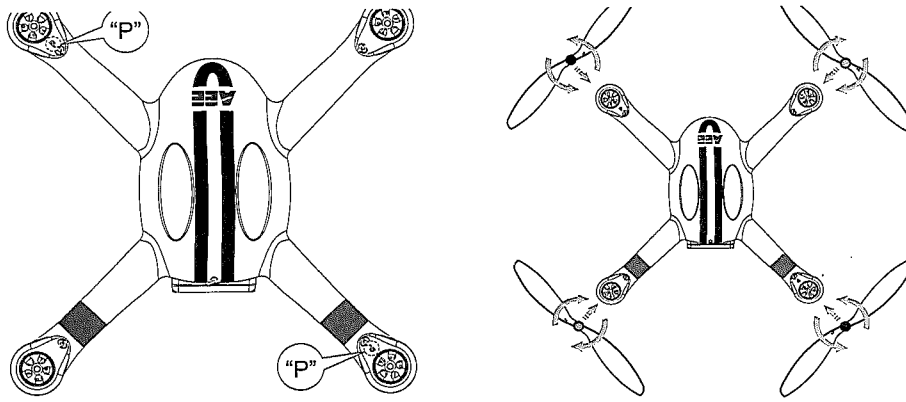

Figure 10

- (1) Propellers are designed to self-tighten during flight; therefore do not tighten them excessively. Do not use glue on the threads.
- (2) Ensure propellers are attached in the correct position. The quadcopter cannot fly properly if the propellers are installed incorrectly. Wear protective gloves while installing as propellers are very thin and may cause accidental scratches.

### 3.3 Disassembling Propellers

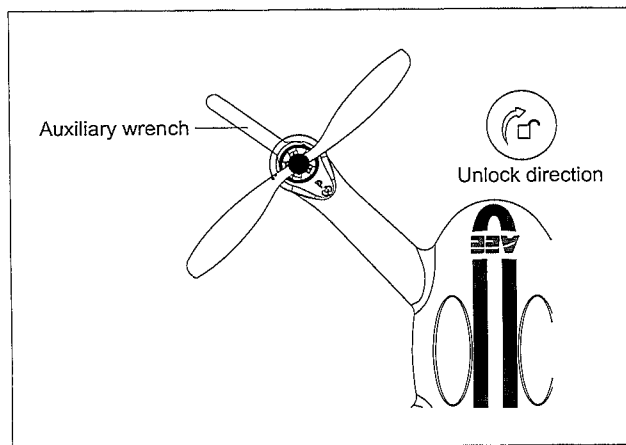

Figure 11

**⚠** As shown as in the Figure 11, prevent motor rotation by using the auxiliary wrench or your hand, then remove propeller by turning towards the unlock direction.

### 3.4 Precautions

- (1) Check whether propellers and motors are installed correctly and firmly before every flight.
- (2) Ensure that all propellers are in good condition before each flight. Replace aged, chipped or broken propellers.
- (3) To avoid injury, stand clear of and do not touch propellers or motors when they are spinning.
- (4) Only use original AEE propellers for a better and safer flight experience.

#### **⚠ Warning :**

- (1) When installing the propellers, rotate the propellers strictly in the lock direction specified by the mark, and DO NOT apply too much force in order to avoid possible damage.
- (2) When removing the propellers, rotate the propellers strictly in the unlock direction specified by the mark, in order to avoid possible damage.
- (3) Do not remove the propellers immediately after flight, because the temperature of the motor is too high to cause scald, please wait until the motor is cold down.

## 4 Preparing the Remote control

Quadcopter Remote control is paired with the Quadcopter receiver before delivery. The Remote control is set to U.S. mode by default.

- Control Mode: The Remote control is set to U.S. mode or Japanese mode based on joystick channel mapping.
- U.S. mode: The left joystick controls throttle.
- Japan mode: The right joystick controls throttle.
- Repeater mount is already installed on the Remote control before delivery. Please install the Smartphone Holder before installing a mobile device on the Remote control.
- Over sized mobile devices (such as iPad) are not recommended as they cannot be installed on the holder.

### 4.1 Introduction

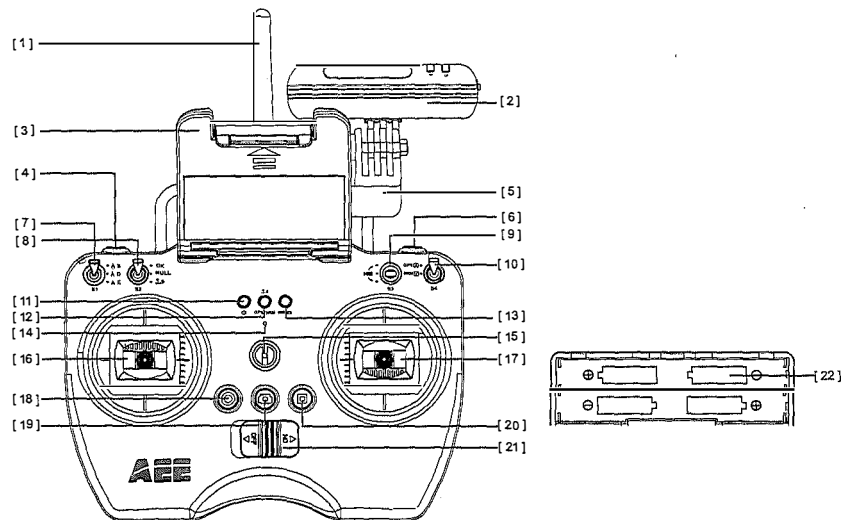
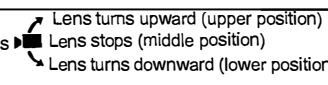

Figure 12

No.	Description	Specification Definition
1	Antenna	Remote control signal transmission
2	Repeater	For extending Wi-Fi signal reception range
3	Mobile device holder	For attaching mobile devices
4	Hook open/close button	Short press it once to open the hook on the quadcopter; press it again to close the hook (Remark: The hook is an optional accessory)
5	Repeater base	It is used to fix the repeater
6	Return button	Long press it for 3s to send a go-home command to the quadcopter
7	Speed switch S1	There are three speed modes; the speed decreases from up to down: 1. <b>S</b> Sport mode; 2. <b>D</b> Drive mode; 3. <b>E</b> Economic mode;
8	Calibration switch S2	It is a 3-channel switch. 1. <b>OK</b> (joystick calibration is OK); 2. <b>NULL</b> (Reserved function); 3. <b>Start</b> (start the joystick calibration procedure)
9	Gimbal control switch S3	Diagram of PTZ motion control switch positions  When it is turned upward/downward, the lens direction changes slowly till the allowable maximum angle is reached
10	Flight mode switch S4	It is a 2-channel switch. 1. <b>GPS</b> GPS mode; 2. <b>NRM</b> NRM mode (normal mode); Remark: When the quadcopter is in the auto fly mode (auto return, low-battery auto landing), at the time when the remote control signal is restored, switch between the GPS and NRM modes twice to end the auto fly mode and now the remote control can regain control of the quadcopter
11	Remote control power indicator	Red, indicating the remote control power ON/OFF status (red light remains on when the power is turned on, and blinks slowly in low-battery status)
12	Status indicator	Tri-color indicator It can indicate the GPS signal status and flight mode of the quadcopter, and also the joystick calibration status. Remark: For the sake of safety, the quadcopter should be turned off before joystick calibration
13		
14	Buzzer hole	Warning tone
15	Strap hole	Used to hang the remote control
16	Left joystick	2 channels;"up-down" channel controls gas, "left-right" channel controls yaw.
17	Right joystick	2 channels;"up-down" channel controls roll, "left-right" channel controls pitch
18		
19		
20		
21	Remote control power switch	Slide it to the left position to power OFF the remote control; slide it to the right position to power ON the remote control
22	Battery compartment	It is where the battery is installed

Note:

- When the airborne camera is S60 plus, the photo shooting & video recording indicator can only keep remaining on.
- When the airborne camera is S60 Plus, the photo shooting button, video recording button and video recording stop button are invalid.

After startup of the quadcopter, the user can judge the current status of the quadcopter according to the status indicator. The status indicator is on the remote control, as shown in Figure 13, the three indicators from left to right are power indicator (red), status indicator (tri-color: red/green/blue), and Photo shooting & video recording indicator (green).

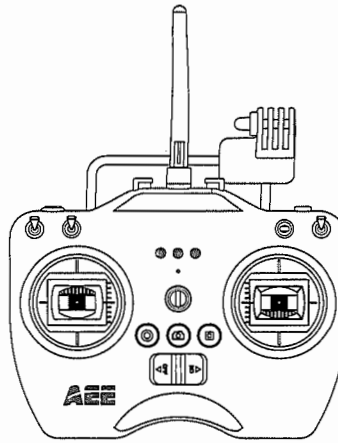

Figure 13

Indicators on the remote control		
Power indicator	Status indicator(tri-color light)	
Red light ●	Red light ● /green light ● /blue light ○	Function status
Remaining ON	N/A	Power on
Remaining ON	Red light remains ON	Abnormal condition, as signal loss etc.
Remaining ON	Blue light remains ON	Indicates that signal connection is normal and the quadcopter is in the GPS signal searching status.
Remaining ON	Green light remains ON	Indicates that signal connection is normal and GPS signal is good
Remaining ON	Blue light blinks	Indicates that the quadcopter is in the GPS signal searching status and in the auto flight mode (low-battery auto landing); now the remote control can regain control of the quadcopter via the S4 switch.
Remaining ON	Green light blinks	The first situation indicates that the GPS signal is good and the quadcopter is in the auto fly mode (1. auto landing, or 2. low-battery auto landing); now the remote control can regain control of the quadcopter via the S4 switch. The second situation indicates the joystick calibration status. During calibrating, the indicator blinks. When the green light will go out, the calibration completes successfully. If the calibration does not complete, the green indicator will continue blinking.

1) When Remote control battery power is low, a warning alert sounds (di didi di didi...).

### 4.3 Powering on the Remote control

- (1) Load four AA batteries into the battery compartment. Pay attention to positive and negative directions.
- (2) Set S1 and S2 switches to the upper-most position and place both joysticks at the mid-point (For indoor flight, please turn S4 to the middle position, otherwise the quadcopter can not be started).
- (3) Toggle power switch to ON position, to switch on the Remote control.
- (4) The power indicator remains ON in red color after the Remote control is powered on.
  - Ensure batteries of Remote Control have been fully charged before each use. If there is low voltage, the Remote control will prompt low power warning ( di didi di didi... ). Please replace batteries immediately.
  - Be sure to remove batteries from remote control in case of long-term storage.
  - Remove depleted batteries and follow battery instructions for disposal or recycling.

**Warning:** Make sure not to touch the propellers when operating Remote control.

### 4.4 Antenna Orientation

Keep the remote control antenna pointing skyward, and ensure there are no obstacles between remote control and receiver antennas, to ensure maximum remote control range during flight.

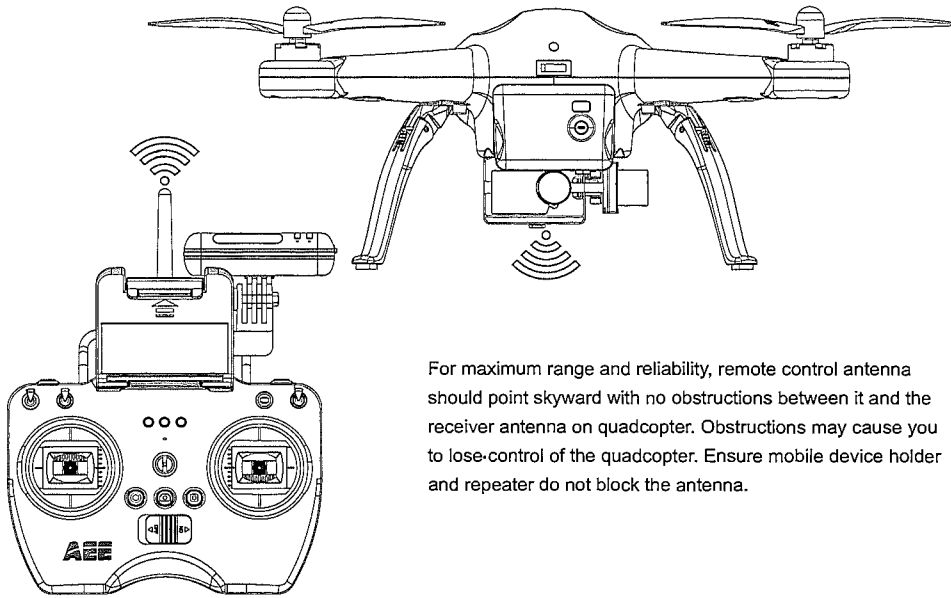

For maximum range and reliability, remote control antenna should point skyward with no obstructions between it and the receiver antenna on quadcopter. Obstructions may cause you to lose control of the quadcopter. Ensure mobile device holder and repeater do not block the antenna.

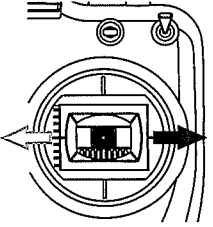
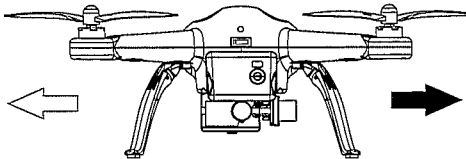
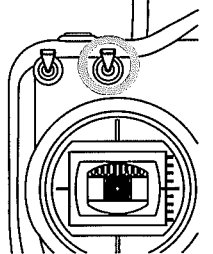
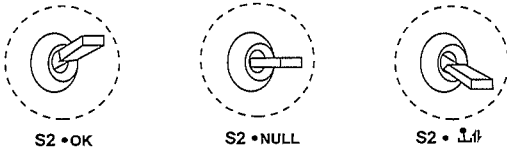

Figure 14

### 4.5 Operating the Remote control

**Joystick at center / neutral:** Control joysticks of remote control are at the central position.

**Joystick deviation distance:** The distance the remote control joystick deviates from its center position.

Remote control (U.S. Mode)	Quadcopter Direction ("←" indicates nose direction)	Operation Details
		Vertical movements on the left joystick control quadcopter elevation. Push the left joystick up to ascend and down to descend. When both joysticks are centered (neutral), the quadcopter will hover in place (height is automatically set). Push the left joystick upwards beyond the center (neutral) position to take off. (Push the left joystick slowly to prevent sudden and unexpected elevation).
		Horizontal movements on the left joystick, controls the rudder. Push left to rotate quadcopter counterclockwise and right for clockwise. If the joystick is centered, the quadcopter flies in the same direction without rotating. The joystick controls the quadcopter's rotating velocity. The more the joystick is moved the faster the quadcopter will rotate.
		Vertical movements on the right joystick, controls the quadcopter's forward & backward pitch. Push up to fly forward and down to fly backward. The quadcopter will keep level and straight if the joystick is centered. Push the joystick further to increase pitch angle and faster flight velocity.

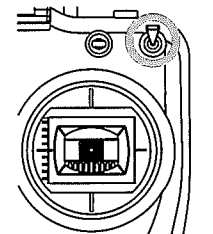
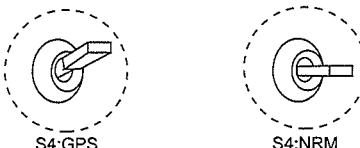
		<p>Horizontal movements on the right joystick control left and right pitch.  Push left to fly left and right to fly right.  The quadcopter will keep level and straight if the joystick is centered  Push the joystick further to increase pitch angle and faster flight velocity.</p>
	 <p>S2 • OK      S2 • NULL      S2 • </p> <p>Position-1      Position-2      Position-3</p>	<p>The S2 switch is used for calibration of the joystick. Turn S2 to position 3, then turn on the remote control, and at this time the status indicator starts blinking (indicating joysticks calibration starts). Turn the left and right joysticks clockwise and counter-clockwise respectively at the maximum stroke for two circles, and then release the joysticks. (ensure that the joysticks stay at the maximum stroke throughout this process) Then, the status indicator in the middle will go out. Last, turn S2 to position 1, the photo shooting &amp; video recording indicator will light up (green). Now the calibration completes successfully.</p>
	 <p>S4:GPS      S4:NRM</p> <p>Position-1      Position-2</p>	<p>The S4 switch is used to switch the flight mode.  Position 1 (GPS) is GPS mode;  Position 2 (NRM) is Normal mode;</p>

- In GPS mode, when all joysticks are in the neutral position, the quadcopter hovers at a fixed-point.
- In Normal mode, when all joysticks are in the neutral position, the quadcopter remains level, but may drift in a horizontal direction.
- When S4 switch to GPS Mode, the motor can not be turned on until GPS is ready (the tail light remains on).

#### 4.6 Frequency Pairing between Remote control and Receiver

The Remote control and receiver are paired before delivery. Normally, you can skip this procedure and directly use the quadcopter. However, if you change the Remote control or Receiver, frequency-pairing is required.

##### Frequency Pairing Procedures

- (1) Important: Be sure to remove propellers before pairing to avoid accidental injury.
- (2) When the remote control is turned off, power on the quadcopter. Now the arm lights and the quadcopter tail light come on. When a "beep" sound is heard, turn on the remote control; the remote control power indicator (red) will come on. When the "status indicator" on the remote control changes from red to blue, it indicates pairing is successful.
- (3) If the "status indicator" on the remote control does not change from red to blue (i.e. remains in red), repeat step (2) until the pairing is successful.



## 5 Preparing the Repeater

Quadcopter Wi-Fi Repeater is a wireless communication device that operates within the 2.4 GHz frequency band. It is used to extend the communication distance between the mobile device and quadcopter. Communication distance is affected by the surrounding environment, such as blockages due to trees, signal reflection by buildings, interference by other same frequency bands, etc., affecting effective communication distance. Before every flight, ensure the Wi-Fi Repeater works properly, otherwise communication issues between the mobile device and quadcopter may occur.

### 5.1 Introduction

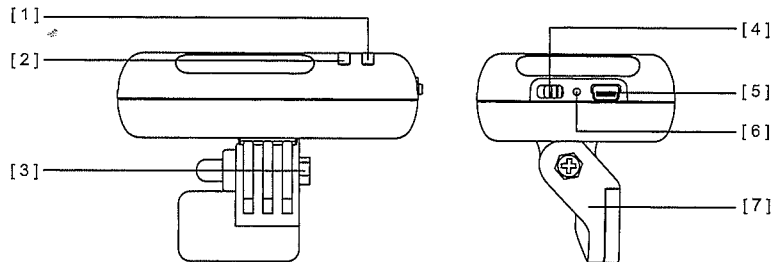

Figure 15

- [ 1 ] Power Indicator
- [ 2 ] Wi-Fi Indicator
- [ 3 ] Lock screw
- [ 4 ] Power Switch
- [ 5 ] Charging Port (Mini USB port)
- [ 6 ] Pairing Button
- [ 7 ] Repeater Base

#### 5.1.1 Wi-Fi Indicator

Indicates Repeater's Wi-Fi status

Wi-Fi Indicator	Description
Blue light is ON	Wi-Fi Repeater is working properly
Blue light blinks fast (1.5s OFF, 0.3s ON)	Wi-Fi Repeater is pairing with airborne Camera
Blue light blinks slowly (3s OFF, 0.3 ON)	Wi-Fi Repeater is successfully paired

#### 5.1.2 Power Indicator

Indicates Repeater's power supply status.

Power Indicator	Description
Red light is ON	Repeater power supply is normal or charging completes
Red light blinks	Repeater is charging, or Repeater power is running out, please charge as soon as possible

#### 5.1.3 Pairing Button

When the repeater is on, press and hold the Pairing Button for 3 seconds, the repeater will automatically restart for code re-pairing. Press and release the Pairing button to check repeater's power level.

Press Pairing button	Press Pairing button once: If Power Indicator blinks once, indicates that repeater has over 80% charge available If Power Indicator blinks twice, indicates that repeater has over 50% charge available If Power Indicator blinks three times, indicates that repeater is running out of Power
Long press Pairing button (3 seconds)	Repeater restarts and you can re-pair codes

#### 5.1.4 Code Pairing

If the Wi-Fi indicator fast blinks blue (1.5 seconds OFF, 0.3 seconds ON), or keeps ON, it is necessary to carry out pairing please re-pair with following steps:

- (1) Switch on the power switch and Wi-Fi switch of camera, then switch on the power switch of repeater.
- (2) After the Wi-Fi indicator of camera blinks, and Wi-Fi indicator of repeater is on, press Pairing Button of repeater until Wi-Fi indicator (blue) of repeater blinks fast (0.3s on, 1.5s off). Then press the "video recording stop button" of camera immediately (1 time per second).

When the repeater blue light indicator slow blinks (0.3s on, 3s off), this indicates the pairing completes.

- (3) If pairing fails, please repeat step 1 and step 2.

## 5.2 How to use

### Charging the Repeater

Connect the repeater to the Repeater Adapter through the Mini USB port. It takes about 2 hours to fully charge the battery.

- Ensure the repeater has sufficient charge before each flight.

### Switching on the Repeater

- (1) Toggle Repeater power switch to ON.
  - (2) Wait until the Wi-Fi indicator blinks blue, indicating the Repeater is communicating properly.
  - (3) While using, ensure the Repeater's LED side faces you, and ensure that visibility between the Repeater and quadcopter is unobstructed, to obtain maximum communication distance.
- After the flight, in addition to switching off the quadcopter and remote control, remember to switch off the Repeater, or else the Repeater's battery will be depleted.

## Download AEE App (iOS / Android)



Scan QR Code above

Download the AEE ZONE App to watch live video when using Quadcopter, through the following method. For iOS users, please search "AEE ZONE" in the App Store, download and install the App on your mobile device. For Android users, please search "AEE ZONE" in the Google Play.



AEE ZONE



iOS 8.0 or above



Android 4.0 or above

## Compatible Mobile Devices

iOS (System version iOS 8.0 or above): Applicable for iPhone mainstream models.

Android (System version 4.0 or above), Applicable for mainstream models.

- AEE will provide updates on future support for more types of mobile devices.

## 7 Connecting the Camera

Follow the below procedures to connect the camera and the mobile device:

- (1) Power on the remote control, camera and Wi-Fi repeater. (Note: Do not power on the quadcopter before Wi-Fi function of camera starts up.)
- (2) Wait for about 22s, the Wi-Fi indicator (blue) of camera blinks and the Wi-Fi indicator (blue) of Repeater blinks slowly (0.3s on, 3s off). Now open the Wi-Fi function of mobile device. Please put the mobile device close to the repeater.
- (3) Select "AEE\_AP\*\*\*\*\*" from the Wi-Fi network list and join in it.
  - Please make sure that the mobile device close to the Wi-Fi repeater in order to get better performance of video transmission.

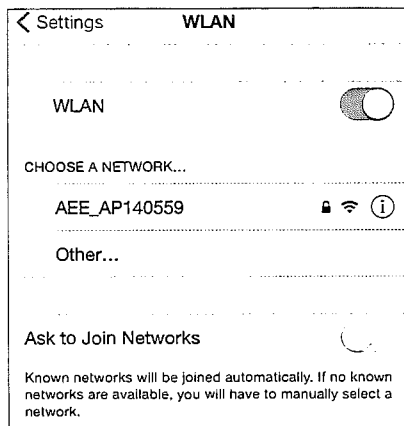

Figure 16

- Select this network and enter the password "AEE12345" to join the network.
- (4) Launch APP ZONE, click the "CONDOR" on the interface, slide the screen and select the "AP Series". Click the "Connect" and the camera will be connected with mobile device.

# Flight

After installation, please conduct flight training (for example: Flight simulator training or professional training). Ensure that all flights are carried out in a suitable environment.

## Flight Environment Requirements

- (1) Do not use the quadcopter in severe weather conditions, such as strong winds (category 4 and above), snow, rain and fog.
- (2) Fly in an open area without tall buildings. Presence of large number of steel buildings in the area will affect the onboard compass.
- (3) Keep quadcopter away from obstacles, people, power lines, trees, shelters, surface of the water, etc., during flight.
- (4) Reduce the chance of electromagnetic interference by not flying in areas with high levels of electromagnetism (such as near mobile phone base stations or towers).
- (5) This product cannot be used in The Antarctic Circle and The Arctic Circle.
- (6) Do not fly the quadcopter within restricted or no-fly zones, and abide by local laws or regulations.

## Pre-flight Check:

- (1) Ensure remote control, quadcopter, Wi-Fi repeater and mobile device are fully charged.
- (2) Ensure propellers are correctly assembled.
- (3) Ensure the Micro SD card is properly loaded before photo capture and video recording.
- (4) Ensure the quadcopter, remote control and other equipment are working properly after powering on.
- (5) Check if motors start properly after the quadcopter is switched on. At this time, disassembling propellers is recommended for safety.
- (6) Check if the AEE ZONE App is properly connected to the camera.



## 1 Compass Calibration

Compass calibration is required before first time use otherwise the system may not work properly, affecting flight safety. The compass is sensitive to electromagnetic interference from other electronic devices, which can cause abnormal compass data leading to poor flight performance or even flight failure. Regular calibration is required for optimum performance.

- Do not calibrate the compass in a strong magnetic field.
- Do not carry ferromagnetic material, such as keys, cell phones, etc., while calibrating the compass.

### 1.1 Calibration Procedures

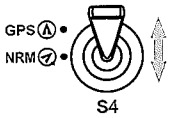
Choose an open space to conduct calibration. Start the remote control and quadcopter and ensure they work properly. Follow the below procedures to calibrate the compass:

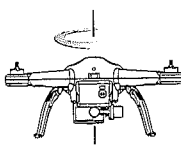
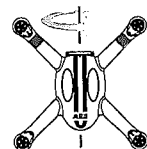
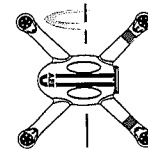
1	2	3	4	5
 <p>GPS Ⓐ NRM Ⓑ S4</p>				
<p>After the quadcopter powers on (about 20 seconds). Switch S4 between GPS and normal mode for more than 5 times. The quadcopter will enter calibration standby mode (the tail light blinks fast).</p>	<p>Toggle the joysticks to the position as shown above figure. Front indicators (green) blinking slowly, then release the joysticks. Compass calibration command has been sent successfully</p>	<p>Rotate quadcopter 360° horizontally (2 turns)</p>	<p>Rotate quadcopter 360° vertically 2 turns (Nose down)</p>	<p>Rotate quadcopter vertically (Nose leftward) until green lights off, put quadcopter on the ground. Green lights up normally after light off → calibration successful; Green lights blink fast after light off → calibration failed → Recalibrate</p>

**Warning:** Be sure to remove propellers before calibration, to avoid accidental injury or loss.

### 1.2 When to Recalibrate

- (1) When compass data is abnormal, front indicator (green) blinks fast.
- (2) The flight location is far from the place where last compass calibration was conducted.
- (3) There are changes in quadcopter's physical structure.
- (4) The quadcopter drifts a lot while flying, such as it flies along a circle when hovering.

## 2.1 Starting the motor

Toggle the joysticks as shown in the illustration (Combination joystick Command [CSC]) to start the motor. Release the joysticks simultaneously after the motors start.

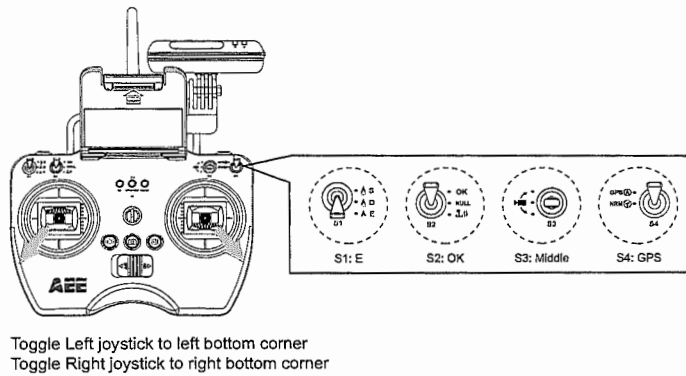

When S4 switch is set to GPS Mode,

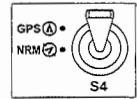

The motor cannot be turned on until GPS is ready (Tail indicator will alternate between fast blinking and on).

Figure 17

## 2.2 Stopping the Motors

There are two ways to stop the motors.

**Method one (Figure 18):** After the quadcopter lands, toggle the throttle joystick to the lowest position and then perform CSC, the motors will immediately stop. Release both joysticks after the motors stop.

**Method two (Figure 19):** After the quadcopter lands, toggle the left joystick to the lowest position and hold for 3 seconds to stop the motor.

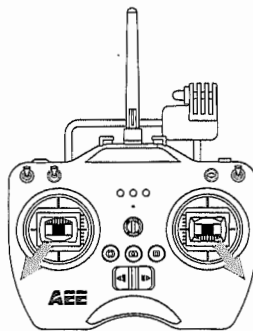

Figure 18

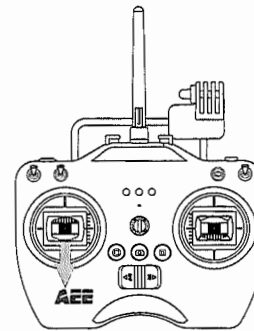

Figure 19

- Do not execute CSC during normal flight. This will stop the motors and cause the quadcopter to drop without control.
- Toggle the joysticks quickly and accurately when performing CSC. Release the joysticks simultaneously after the motors starts or stops.
- Shutdown remote control must be after the quadcopter power off. Otherwise, the quadcopter will enter the return mode, then may case the high-speed rotation of the propeller.

## 3 Basic Flight

### 3.1 Basic Flight Procedures

- (1) Place quadcopter on a flat and open ground, and ensure Tail Indicator faces you.
  - (2) Power on the Camera, Remote control, Wi-Fi Repeater and Quadcopter one after the other.
  - (3) Launch AEE ZONE App, connect the mobile device and quadcopter, and navigate to the camera preview interface.
  - (4) Start the motors until the GPS signal is strong enough (the Tail indicator remains on and Status Indicator is green.) at GPS mode. Or, start the motors when the status indicator on Remote control is blue at NRM mode.
  - (5) Push the left joystick up slowly for a smooth take-off. Please refer to remote control operation instructions for detailed operation procedures.
  - (6) Use the AEE App to capture photos and record videos, and enjoy the flight. Please refer to Using AEE ZONE App for more details.
  - (7) To land, gently pull down the left joystick to make the quadcopter descend slowly to the ground.
  - (8) After landing, execute CSC or pull the left joystick to the lowest position and hold for more than 3 seconds until the motors stop.
  - (9) After motors stop, power off quadcopter, Wi-Fi repeater and the remote control one after the other.
- During flight if all 4 arm indicators slow blink or fast blink, it indicates the quadcopter has entered a low battery state. Please refer to Low Battery Level Alarm Function for details.
  - DO NOT move the camera manually in any case OTHERWISE it will cause the camera to be abnormal. The movement of camera can be controlled only by the Remote Control.
  - After power on the drone, please wait for 30s (for drone preheating) until start up the motors, when the temperature is below 10°C.

General Operating Order List							
Component	Startup Time						
Camera	20s	→	Turn on the quadcopter	→	Start the APP on the mobile device	→	Perform the takeoff operation of the quadcopter
Repeater	22s						
Remote control	10s						

### 3.2 Aerial Photography Tips and Tricks

- (1) Perform pre-flight checks.
- (2) Capture photos and record videos during safe flight status.
- (3) Capture photos and record videos in sunny weather with little wind.
- (4) Set camera settings as per shooting requirements, such as video resolution, picture size, etc.
- (5) Carry out a trial flight before actual flight to help plan the route and frame your photos and videos.
- (6) Push the joystick as slowly as possible during flight to ensure the quadcopter flies smoothly.

## 4 Failsafe Protections

If the quadcopter loses connection with the remote control, the failsafe mode kicks in and the Automatic Flight Control system will control the quadcopter, fly it back to the Home Point and land it safely. This reduces chances of losing or crashing the quadcopter in case the remote control signal is lost.

- Home Point: Indicates the quadcopter's position when the quadcopter successfully scans the GPS signal.

### 4.1 Scenarios when Quadcopter enters Failsafe mode

- (1) When remote control is powered off.
- (2) The quadcopter has flown beyond the effective range of the remote control signal.
- (3) There is interference causing a signal problem with the remote control.

### 4.2 Failsafe Procedure

In case you lose control of the quadcopter during flight, the quadcopter will automatically follow the below operating procedures:

- (1) The quadcopter automatically slows down and hovers in one location.
  - (2) If the quadcopter regains signal from the remote control within 2 seconds, flight control returns to normal mode, and the quadcopter will not enter Failsafe mode and will not automatically fly back to the Home Point.
  - (3) If the quadcopter does not regain signal from the remote control within 2 seconds, the quadcopter enters Failsafe mode, and initiates automatic flight control to fly back to the Home Point. The quadcopter will now continue to hover for 15 seconds and evaluate vertical Distance to the Home Point. If the distance is more than 25 meters, the quadcopter will commence to fly back to the Home Point. If the Distance is less than 25 meters, the quadcopter will fly up vertically to 25 meters higher than the Home Point, and then commence to return. When the quadcopter reaches the Home Point it will hover for 5 seconds and then automatically land.
- To ensure the quadcopter successfully flies back to the Home Point when it is in Failsafe mode, please take-off only after the quadcopter successfully scans the GPS signal.
  - The quadcopter cannot automatically avoid obstacles in its path when it is flying in Failsafe mode.

### 4.3 How to regain control during Failsafe Procedures

When the quadcopter is out of control, toggle the S4 switch on the remote control several times to switch flight mode(GPS<-->NRM). Once the signal is restored, the remote control will regain control, and you can continue to use the remote control to operate the quadcopter.

## 5 Low Battery Level Alarm Function

When quadcopter battery power is low, you must land as soon as possible, or else the quadcopter may lose power completely and crash, damaging the quadcopter or creating a dangerous situation. In order to prevent danger caused by low battery, Quadcopter defines Level 1 low voltage alarm (battery level under 50%) and Level 2 low voltage alarm (battery level under 20%), and sends alarms with indicators on the quadcopter and on the Remote control .

Battery Alarm	Flight indicator light status	Low Power risk prompt
Low Power alarm	4 arm indicators Slow Blink (blinks on and off in 1s intervals)	In level 1 alarm condition, Quadcopter flies normally for few minutes and then initiates Level 2 alarm. Be cautious while flying, keep the Quadcopter within sight and do not to fly too high or too far.
Severe Low Power alarm	4 arm indicators Fast Blink (blinks twice within 1s)	In level 2 alarm condition, Quadcopter flies normally for few minutes and then initiates Failsafe mode and commences to automatically land. Under such a situation, please return and land the Quadcopter as safely as possible, and do not push the throttle hard or make big movements during flight.

NOTE:

- (1) When Severe Low Power alarm, the battery is very low, operating joystick should be soft.
- (2) When landing action starts, if you want to maintain the height of the quadcopter or continue to climb up, you need to push the left joystick upward.
- (3) In order to avoid the battery running out, please land the quadcopter as soon as possible.





# Appendix

## 1 Description of Common Indicators

Normal State	
Front and Rear Indicators remain ON; Tail Indicator remains on.	The GPS signal is strong enough.
Front and Rear indicators remain ON, Tail Indicator Slow Blinks	Searching for GPS signals
Warnings and Abnormal State	
Front and Rear Indicators Slow Blinks	Low Power alarm (first-level low power alarm)
Front and Rear Indicators Fast Blink	Severe Low Power alarm (second-level low power alarm)

Above indicator descriptions refer to common LED indicator states. For specific details, please refer to "Prepare the Quadcopter" in section 2.3 Flight Indicators.

## 2 Specifications

Quadcopter	
Weight	1.65kg / 3.64lbs
Hovering Accuracy	Horizontal: ±2.5m / 8.2ft , Vertical: ±0.8m/2.62ft
Maximum Tilt Angle	30°
Maximum Climb / Descent Speed	Climb: 6 m/s (19.69ft/s); Descend: 4 m/s (13.12ft/s)
Maximum Flight Speed	20m/s(65.62ft/s)(Not recommended)
Diagonal Length	450mm / 1.48ft
Flight Time	20min
Camera(Only for AEE S60 Plus camera)	
Sensor Size	1 / 2.3
Effective Pixels	16 Megapixels (MP)
Resolution	4608x3456
HD Video Recording	Maximum 1080P / 60fps (N system), 1080P / 50fps (P system), 720P/120fps
Remote control	
Data Transfer Distance	≤500m (2296ft)
Working Hours	20h
Operating Current / Voltage	150mA / 6V
Battery	4 AA Batteries
Wi-Fi Repeater	
Operating Frequency	2.4GHz
Communication Distance (open outdoors)	≤150m (1312ft)
Transmitting Power	≤17dBm
Power Consumption	1.5W

## 3 Common Troubleshooting

### 3.1 Solution for remote control joysticks center (neutral) position errors

When there is a big error in neutral position of remote control joysticks, the motors cannot start when performing CSC. Errors in remote control joysticks neutral position usually occur in two cases:

1. When quadcopter is ON and the joystick (except throttle) is not in neutral position-Solution: Move all remote control joysticks to neutral position, and re-start the quadcopter, to re-record the neutral position. If problem persists, it may be caused due to case.
2. Remote control joysticks have been trimmed, leading to deviation in neutral position, i.e., there is a large asymmetry in quadcopter joystick position-Solution: Recalibrate the remote Control.

a) The S2 switch is used for calibration of the joystick. Turn S2 to position 3 , then turn on the remote control, and at this time the status indicator starts

blinking (indicating joysticks calibration starts). Turn the left and right joysticks clockwise and counter-clockwise respectively at the maximum stroke for two circles, and then release the joysticks. (ensure that the joysticks stay at the maximum stroke throughout this process) Then, the status indicator in the middle

will go out. Last, turn S2 to position 1 , the photo shooting & video recording indicator will come on (green) and then go out 3s later. Now the calibration completes successfully.

(b) Re-start the quadcopter, and pay attention whether or not it starts properly. If the problem cannot be solved by the above methods, please send back the remote control to our factory for repair.





### 3.2 Solutions for Accelerometer Abnormalities

#### 3.2.1 Situations requiring recalibration

- 1) The accelerometer data are abnormal; the four arm lights blink fast.
- 2) The mechanical structure of the quadcopter changes.
- 3) The drift distance is significant during flight.

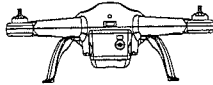
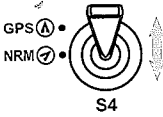
#### 3.2.2 Calibration steps

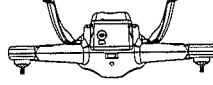
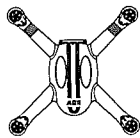
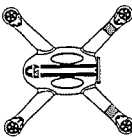
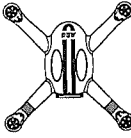
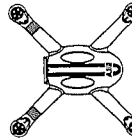
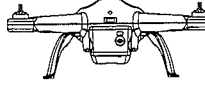
1	2	3	4	5
				
Place the quadcopter on a flat and still ground; turn on the remote control and the quadcopter in sequence	After the quadcopter is normally powered on, turn the S4 switch on the remote control between GPS and normal mode for more than 5 times (i.e., 5 switch cycles); the quadcopter tail light will blink fast, and the quadcopter will enter the calibration standby mode(S4->NRM)	Turn the joysticks of the remote control to a lower toe-in shape until the four arm lights go out, and then return the joysticks to the middle position. Accelerometer command has been sent successfully	When the four arm lights start Remaining ON again, place the quadcopter on the ground upside down (in order to avoid scratch of the housing, it is suggested that sponge should be applied). Turn the joysticks of the remote control to a lower toe-in shape until the four arm lights go out, and then return the joysticks to the middle position	When the four arm lights start Remaining ON again, lean the four supports of the quadcopter against a wall (with the nose facing downward) to make it perpendicular to the ground. Turn the joysticks of the remote control to a lower toe-in shape until the four arm lights go out, and then return the joysticks to the middle position
6	7	8	9	
				
When the four arm lights start Remaining ON again, lean the four supports of the quadcopter against a wall (with the nose facing leftward) to make it perpendicular to the ground. Turn the joysticks of the remote control to a lower toe-in shape until the four arm lights go out, and then return the joysticks to the middle position	When the four arm lights start Remaining ON again, lean the four supports of the quadcopter against a wall (with the nose facing upward) to make it perpendicular to the ground. Turn the joysticks of the remote control to a lower toe-in shape until the four arm lights go out, and then return the joysticks to the middle position	When the four arm lights start Remaining ON again, lean the four supports of the quadcopter against a wall (with the nose facing rightward) to make it perpendicular to the ground. Turn the joysticks of the remote control to a lower toe-in shape until the four arm lights go out, and then return the joysticks to the middle position	At last, if the four arm lights stop blinking fast simultaneously, it indicates the accelerometer calibration is successful. Otherwise, the accelerometer should be recalibrated	

#### Warning:



1. In order to avoid accidental injury or loss, please remove the propellers prior to calibration.
2. DO NOT move the quadcopter before the arm lights come on again.

### 3.3 Solutions for Gyroscope Abnormalities

#### 3.3.1 Situations requiring recalibration

- 1) The gyroscope data are abnormal; the rear arm lights blink fast.
- 2) The mechanical structure of the quadcopter changes.
- 3) The drift distance is significant during flight.

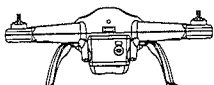
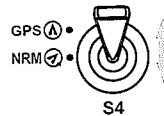
#### 3.3.2 Calibration steps

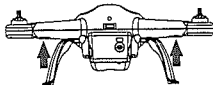
1	2	3	4
			
Place the quadcopter on a flat and still ground; turn on the remote control and the quadcopter in sequence	After the quadcopter is normally powered on, turn the S4 switch on the remote control between GPS and normal mode for more than 5 times (i.e., 5 cycles); the quadcopter tail light will blink fast, and the quadcopter will enter the calibration standby mode(S4->NRM)	Turn the joysticks of the remote control to an upper toe-out shape, wait until the rear arm lights on the quadcopter start blinking slowly, and then release the joysticks. Gyro command has been sent successfully. (Do not move the quadcopter during calibration)	At last, if the rear arm lights (red) remain on, it indicates the calibration is successful. Otherwise, the gyroscope should be recalibrated.

 Warning: in order to avoid accidental injury or loss, please remove the propellers prior to calibration.

### **3.4 Quadcopter is out of sight and the Wi-Fi is disconnected**

Turn off the remote control and let the quadcopter automatically return. Ensure there are no obstructions on the quadcopter's return path, and ensure you are familiar with the procedures on how to regain control of the quadcopter.

Turn off the remote control to trigger the Failsafe mode and the quadcopter will start to fly back, descend, and land at the Home Point. Ensure there are no obstacles between the quadcopter and the Home Point and that you are familiar with the procedure for regaining control.

### **3.5 Wi-Fi could not be re-connected**

This is because after the mobile device disconnects from quadcopter Wi-Fi connection, the mobile device automatically connects to other Wi-Fi networks. Please check your mobile device is connected to the quadcopter Wi-Fi network.

### **3.6 Precautions while using App on multiple mobile devices**

During flight if the App is used on one mobile device and then launched on another mobile device, please make sure you completely log out from the App in the original mobile device, so that the App can be normally used on the other mobile device.

### **3.7 How can quadcopter land smoothly?**

Before performing CSC, pull down the left joystick to less than 5% of the joystick level, and then execute CSC. This way you can land the quadcopter smoothly.

## **Limited Warranty**

AEE products are guaranteed against manufacturing defects, AEE's sole obligation in the event of such defects during this period is to repair or replace the defective part or product with a comparable part or product at AEE's sole discretion. Except for such repair or replacement, the sale, processing or other handling of this product is without warranty, condition or other liability even though the defect or loss is caused by negligence or other fault. Damage resulting from use, accident, or normal wear and tear is not covered by this or any warranty. AEE assumes no liability for any accident, injury, death, loss, or other claim related to or resulting from the use of this product. In no event shall AEE be liable for incidental or consequential damages relating to or resulting from the use of this product or any of its parts. Because of possible user resealing error, this product is not warranted against leakage in waterproof housing or any resulting damage. Returns or replacements of parts and/or products may be subject to shipping, handling, replacement and/or restocking fees.

If you are experiencing a problem with an AEE purchase, please contact our Customer Support Team by visiting our website [de.aee.com](http://de.aee.com) [aeeusa.com](http://aeeusa.com) [aee.com](http://aee.com) .

For product warranty period and conditions, please refer to [de.aee.com](http://de.aee.com) [aeeusa.com](http://aeeusa.com) [aee.com](http://aee.com) for details.

Tip: If you bought this product from an AEE authorized dealer, we would recommend that you first contact them for technical support issues

This User Manual is subject to change without prior notice.

You can check the official AEE website for the latest updated version.

**ACE**

**AEE**

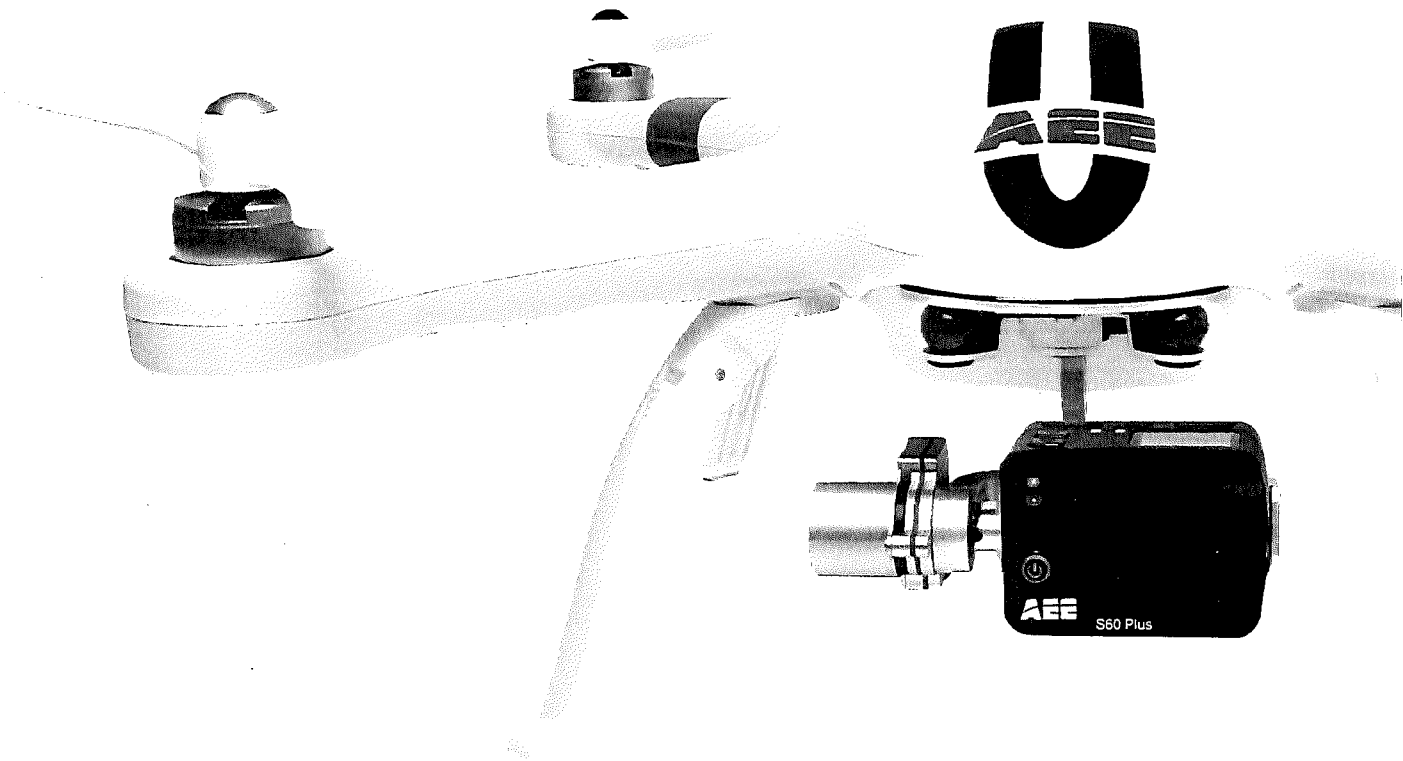

# AEE AP11 Pro Quick Start Guide

## Disclaimer

Please read this disclaimer carefully before using the product of quadcopter. This product is not suitable for people under the age of 18. By using this product, you hereby agree to this disclaimer and signify that you have read them fully. You agree that you are responsible for your own conduct and content while using this product, and for any consequences there of. You agree to use this product only for purposes that are proper and in accordance with the terms and any applicable or guidelines AEE may make available.

1. AEE Aviation Technology reserves the right of final interpretation of this disclaimer. de.aee.com aeeusa.com aee.com
2. Any part of this disclaimer is subject to change without prior notice.
3. This disclaimer is available in multiple languages. In case of any discrepancy, the Chinese version shall prevail.

## Instructions

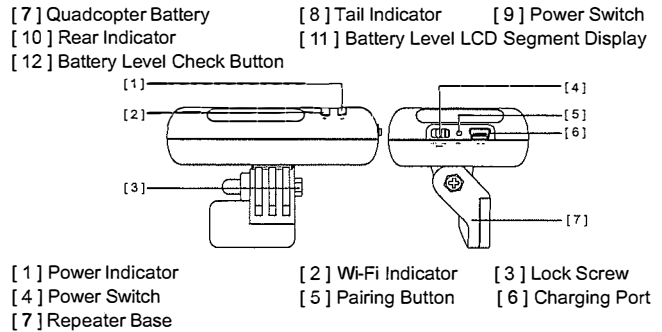
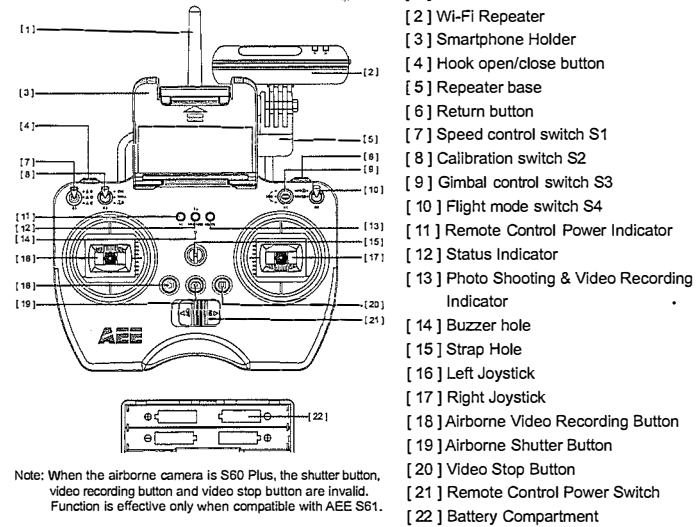

### 1 Download AEE ZONE APP (iOS / Android)



## Operating Instructions

Remote control (U.S. Mode)	Quadcopter Direction (" " indicates nose direction)

### 2 Remove the Buckle and Install the Camera:

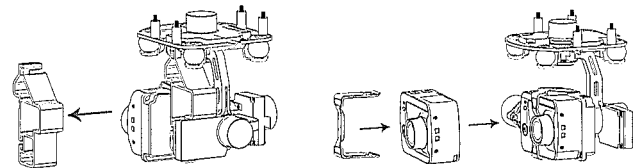

Fig. A

Fig. B

1. Pull out the buckle of the gimbal in the direction shown in Fig. A.
2. Install the camera onto the aircraft and fix the clip to the camera reliably as shown in Fig. B to prevent the camera coming off.

### 3 Preparing the Remote control

### 4 Assembling Quadcopter Battery

- 1) Load battery into battery compartment in the correct direction.

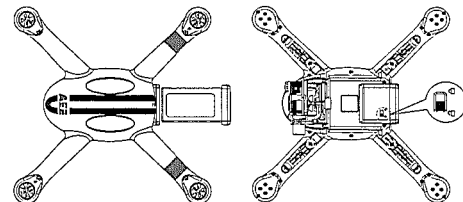

- 2) Ensure that the battery has been completely pushed in. After the battery is completely pushed in, a "click" sound will be heard, indicating that the battery has been fastened. If the battery lock is not tightly locked, poor contact of power supply may be caused, which will affect the flight safety or result in take-off failure.

**! Important:** Pressing the Battery Level Check button to check the battery level. Please fully charge the battery if it is less than two bars showed on the Segment Display.

### 5 Power on Quadcopter

Slide the power switch to "ON" to power on quadcopter.

**! Note:** The general indicator instructions are showed in the following table.

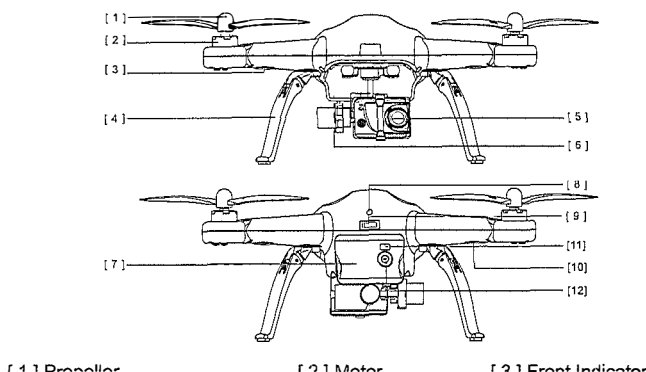

Description	Power on sensor (on), Searching satellites (blinking slowly), Searching completed (remaining on)
-------------	--

WARNING	Front Indicator (green)	Rear Indicator (red)
1st Level low battery alarm	Slow Blink(1s ON,1s OFF)	Slow Blink(1s ON,1s OFF)
2nd level low battery alarm	Fast blink twice per second	Fast blink twice per second

Remote Control Indicators			
Functional status	Power indicator	Status Indicator	Photo Shooting & Video Recording Indicator
Startup	Remains ON	NONE	NONE
GPS normal	Remains ON	Green light	NONE
GPS searching	Remains ON	Blue light	NONE



Note: The Remote Control will be started fully when the Photo Shooting & Video Recording Indicator turns on.

### 6 Compass Calibration

Compass calibration is required before first time use otherwise the system may not work properly, affecting flight safety. The compass is sensitive to electromagnetic interference from other electronic devices, which can cause abnormal compass data leading to poor flight performance or even flight failure. Regular calibration is required for optimum performance.

• **Attention:** Do not calibrate the compass in environments with a strong magnetic field (such as near power lines or radio towers); Do not carry ferromagnetic materials when calibrating the compass, such as keys and cell phones etc.

⚠ **Note:** Calibration can begin until the remote control and quadcopter start up completely (powered on for about 20 seconds).

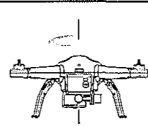
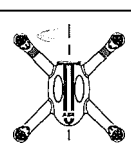
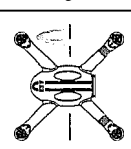
1	2	3
		
After the aircraft is normally powered on, turn the S4 switch between GPS and normal mode for more than 5 times. The quadcopter will enter calibration standby mode (the tail light blinks fast).	Toggle the joysticks to the position as in the follow figure, front indicator (green) starts blinking slowly, then release the joysticks. Compass calibration command has been sent successfully.	Rotate quadcopter 360° horizontally (2 turns)
4	5	
		
Rotate quadcopter 360° vertically 2 turns (Nose down)	Rotate quadcopter vertically (Nose leftward) until green lights off, put quadcopter on the ground. Green lights up normally after light off→ calibration successful; Green lights blink fast after light off→calibration failed →Recalibrate	

### 7 Switching on the Repeater

⚠ **Important:** Wi-Fi Repeater power is running out or is charging when the red light blinks. If the power is low, please charge it as soon as possible.

### 8 Connecting the Camera

1. First, turn on the repeater and camera, and enable the Wi-Fi function of the camera (Press the stop button for 3s to start the camera Wi-Fi, DO NOT turn on the aircraft before the Wi-Fi function of the camera is enabled).
2. Wait for about 25s until the blue Wi-Fi indicator light on the camera blinks. When the blue Wi-Fi indicator light on the repeater starts blinking slowly (off for 3s and on for 0.3s), enable the Wi-Fi function of the mobile device. In order to ensure signal strength, please place the mobile device as close as possible to the repeater. Select "AEE\_AP\*\*\*\*\*" in the Wi-Fi list, and enter the password "AEE12345" to join the network.

### Taking off and Landing (Outdoors)

#### Taking off:

- 1) Place quadcopter (with full power battery) on a flat and open ground, and ensure tail indicator faces toward you.
- 2) Turn on the remote control, repeater and camera and enable the Wi-Fi function of the camera in sequence; last, turn on the aircraft (Do Not turn on the aircraft before the Wi-Fi function of the camera is enabled);

General Operating Order List					
Unit	Duration				
Camera	20s	→	Power on	→	Run the APP
Repeater	22s				
Remote Control	10s				
				→	Take off

- 3) Be sure the remote control is set exactly as the figure below.

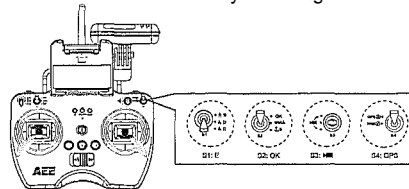

- 4) Starting motors: toggle the left joystick to left bottom corner and toggle right joystick to right bottom corner at the mean time to start motors. Once the motors start please release the joysticks immediately.
- 5) Push the left joystick slowly, then quadcopter take off. Please refer to AEE Quadcopter User Manual for more details.

⚠ **Note:** The motors can not be started until GPS signal is ready (Tail Indicator (green) remains on).

1. Upon startup, the airborne camera and the repeater will pair with each other. Please wait for about 30s to ensure that pairing is completed, so that the airborne camera can record videos normally.
2. After the aircraft is powered on, the aircraft and the PTZ will start self-test. Do not shake the aircraft or the PTZ at this moment; otherwise, the aircraft and the PTZ will fail the self-test. (The PTZ can be used only when the camera is installed; otherwise the PTZ may be damaged)
3. Before installing the camera onto the aircraft, it is suggested that the auto standby function of the camera should be disabled.
4. When the aircraft complete searching for GPS satellites, the tail light (green) will remain on. During flight, please do not turn the joysticks of the remote control to a lower toe-out pattern, which will stop the motors.
5. After power on the drone, please wait for 30s (for drone preheating) until start up the motors, when the temperature is below 10 °C.

#### Landing:

- 1) Slowly pull the left joystick to lower quadcopter until it touches the ground (only on flat and open ground).
- 2) After landing, pull the left joystick to the lowest position and hold for more than 3 seconds until the motors stop.
- 3) Power off quadcopter by sliding the switch to OFF.
- 4) Remove the battery.
- 5) Power off Remote control and Wi-Fi Repeater.

#### ⚠ Important:

- 1) Control the flight height under your control during your first flight.
- 2) Do not toggle the left joystick to left bottom corner and toggle right joystick to right bottom corner during flight, or it will cause the motors to stop working and the quadcopter will drop without control.

